



HYDRAULIC IRONWORKERS & PUNCHING MACHINES



**Multi-Function
Excellent Quality
Economical Investment**

INTRODUCTION

With a highly dedicated team, Sunrise Fluid Power Inc. has been specializing in the manufacturing of hydraulic ironworkers, punching machines, bending machines, and other hydraulic machinery and equipment for near 30 years. Total customer satisfaction is our number one goal. We are passionate about providing engineering excellence in everything we do, and we are dedicated to manufacturing world-class, high-value products for our global customers.

Product Differentiation

Sunrise is ISO-9001 certified by BVQI, and our products meet the CE safety requirements and regulations. We relentlessly seek continuous improvement and product development. Currently Sunrise has the broadest range of ironworker and punching machine models compared to any other manufacturer. Sunrise product advantages: Durability, Accuracy, and Versatility. Besides our very popular single and dual operator models, we have introduced the K-series, a new line of ironworker with vertical movement at all stations. The center beam in the entire range of K-series moves in straight up and down motion to provide less deformation, better results and longer tooling life.

Quality Control

Quality of the highest standard is the key factor in success. All key components of our ironworkers, punching machines, etc. are made in-house at our modern plant and automated production lines. We use the latest control system to ensure highly efficient production, and the quality assurance team measures and tests each component to ensure precision standards of machined parts are met or surpassed. Finally, before shipping, each complete machine goes through intensive quality and performance tests to make absolute sure it meets our strict company quality standards before it arrives at the customer's operation.

Sales and Service

Our global sales network covers almost 50 countries in Europe, Australia, North America, Southeast Asia, the Middle East and more. This coverage, combined with the quality of our machines, makes Sunrise one of the best choices when it comes to metal forming. In this highly competitive international market, Sunrise's market share continues to grow. Thank you to our many and growing list of satisfied customers for your continued support. Sunrise is now one of the leading brands in the fabricating industry. We look forward to your continued support and comments -- together we will push quality at Sunrise ever higher.

Sunrise Hydraulic Ironworkers are designed with multiple functions to save labor, time, energy and cost. This allows Sunrise Ironworkers to meet the diversified needs of the metal fabricating industry.

Maximum efficiency and long life is guaranteed by using the latest manufacturing methods, including powerful CAD design, modern production line with CNC equipment and continuous quality control.

Each work station is equipped with specially designed hold-downs to ensure safety while providing precision and ease of use. These ironworkers are the most economical and efficient machines in the industry for the manufacturing of metal products.

All Sunrise ironworkers and punching machines come standard with a low pressure tool alignment mode. The operator can use the JOG mode to run the machine in low pressure and low speed for tool alignment, blade changes and maintenance operations. This greatly improves operator safety and prevents tool damage in case of mis-alignment.



Key features on the dual cylinder models:

The dual cylinder models feature a separate cylinder for independent operation from shearing stations.

Cylinder ram with flat surface for rigid guiding and to ensure proper alignment of tool.

Keyed punch ram to ensure alignment of shaped tooling.



The cylinder ram is guided at three positions to provide extra support and absorb side-load forces for added protection of cylinder seals.

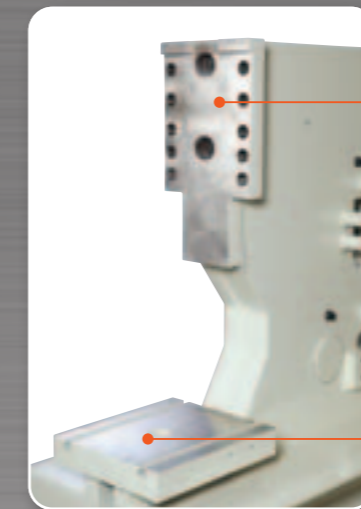

The punching station features a large cylinder mounting plate to ensure maximum cylinder support under heavy load. The punching base is one solid plate with T-slot grooves for universal tool fixture.

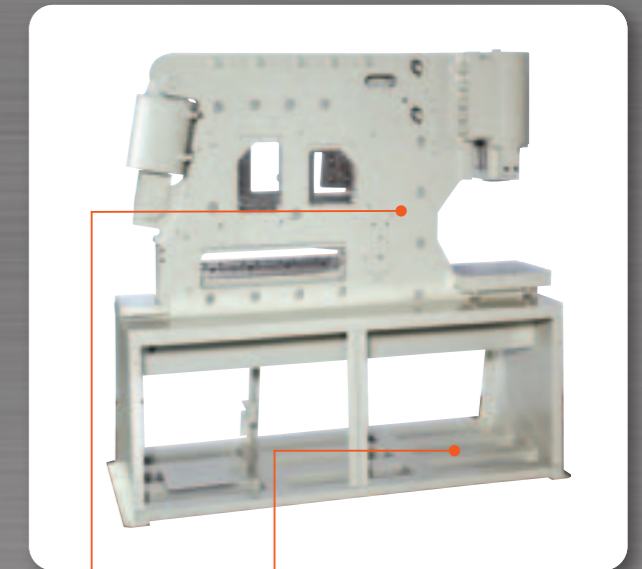





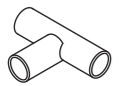

The base of the machine is made from welded channel in a grid pattern for a rigid machine foundation.

The frame of the machine is a monoblock construction that integrates both bolts and welding reinforcement to provide maximum frame structure rigidity.

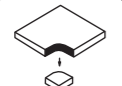
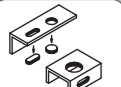
FEATURES

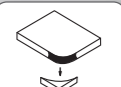
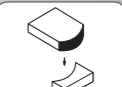
HYDRAULIC IRONWORKERS & PUNCHING MACHINES





	
*Pipe Notching	Punching
	
*Angle Bending	*Radius Corners
	
Punching	*Pipe Punching
	
*Rounding off Corners	*Cutting and Rounding off
	
*Press Brake	*Bilateral Rounding off

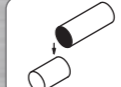
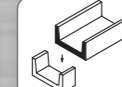
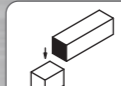
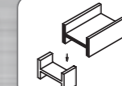

IW-165SD

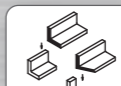
* : Optional tooling

	
Round Bar Shear	*Channel Shear
	
Square Bar Shear	*I Beam Shear

			
Angle Shear	*Vee Notching	Notching	Notching

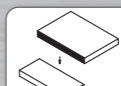
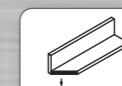
	
Flat Bar Shear	Angle Miter Shear



The use of name-brand hydraulic components ensure excellent reliability of the hydraulic system.



Electric cabinet with low 24 volt DC control circuit provides full protection and safety.

WORK STATIONS

Punching Station

- A full range of punches and dies are available for various punching needs.
- Quick change retaining nut system for fast punch tooling change.
- Thoughtfully designed stripper for visibility, safety and ease of use.

- A large 2-piece table with scales and gauging stops is standard on all models.
- Stripper with interchangeable plates of various openings to minimize deformation is standard on all models.
- Optional hydraulic stripper is available on dual-cylinder ironworkers and all punching machines.



*Punches and dies are sold separately.



*Standard dual-opening die block for up to 50mm round punch and die.



*Multi-stop gauge table. (S/SD/KD and PM models only)

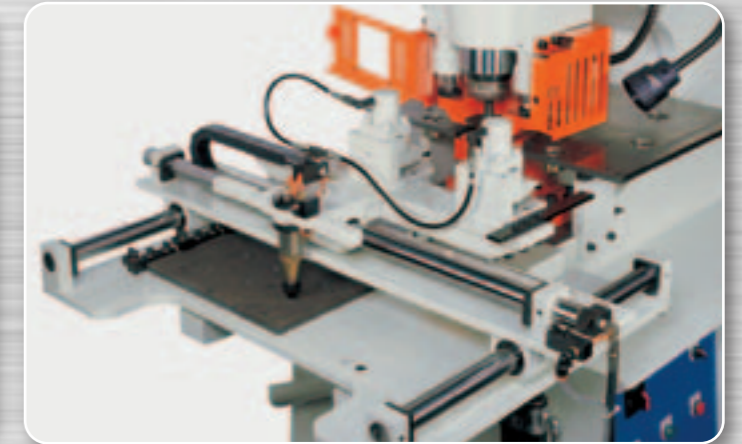

*Optional duplicating table with hydraulic stripper and hydraulic clamping for fast and accurate repetition work. (S/SD/KD and PM models only)

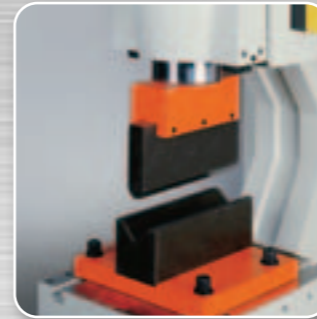

*Single vee press brake.

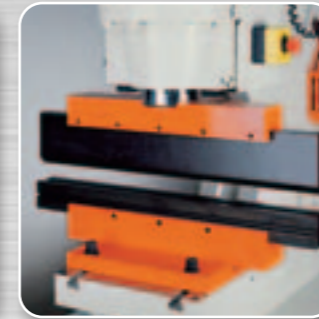

*Multi vee press brake.

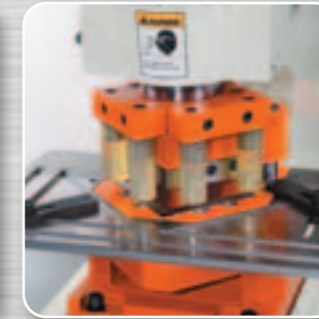

*Large vee-notcher. (Punch side)



*Angle bending press.



Overhang die holder for punching channel flanges and angles. (optional on single cylinder models)



*Laser alignment system for more accurate positioning of marked parts.



*Goose-neck die holder for punching channel flanges and webs.



*Urethane spring stripper for minimal deformation.



*Pipe notcher.



*Oversize punch attachment.

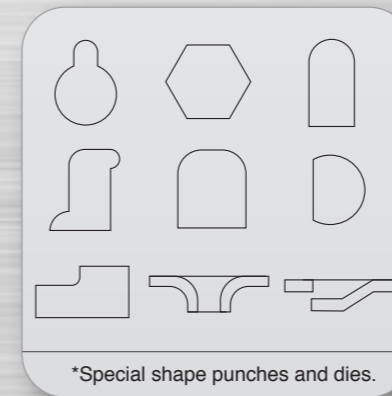

*Special shape punches and dies.

*Optional Semi-Automatic CNC Tables with 1000x400mm travel.



* : Optional tooling

Flat Bar Shearing Station

- Specially machined upper blade to give a clean shear with minimum distortion.
- Lower blade has four usable cutting edges.
- Variable degree miter-cutting on angle flange.
- Easily adjustable hold-down.
- Support table with guides for accurate positioning.

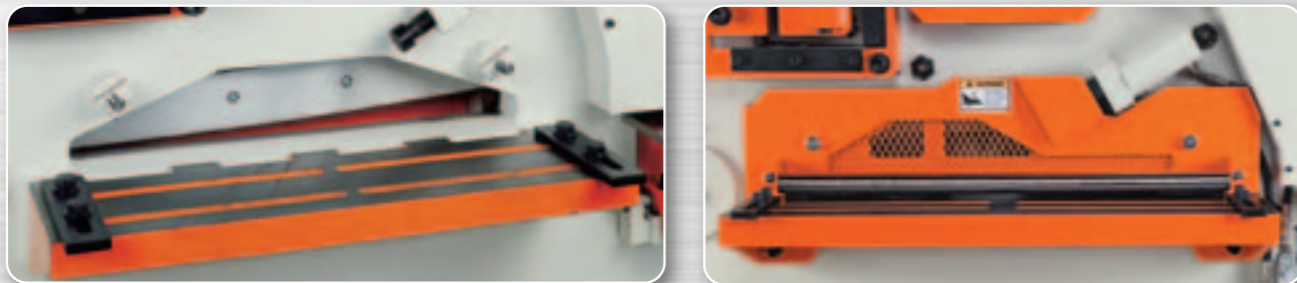

*Optional hydraulic hold-down for double cylinder ironworkers. (Standard on IW-165SD)

Angle Shearing Station

- Single shear with no material loss and minimal deformation.
- 45° miter-cut is easy and clean.
- Stationary blades with four usable cutting edges.
- Selectable corner radii on moving blades for optimum results on small or large angles.



*Optional hydraulic hold-down for angle shear.

Notching Station

- Ideal for notching of flat bars and angles.
- Electrically interlocked safety guard for maximum safety and visibility.
- Gauging table included with stops for precise positioning.

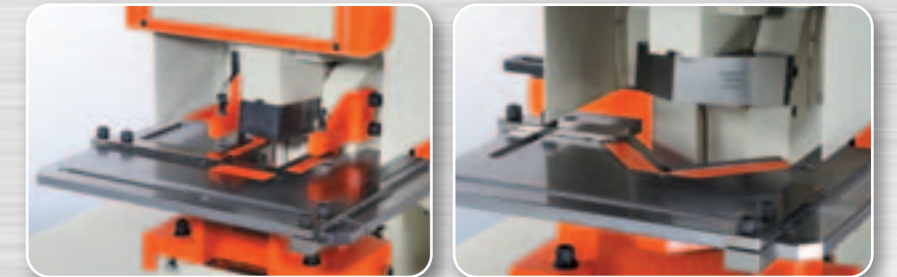

*Optional.

Bar Shearing Station

- One hold-down for various sizes of square bar shearing and round bar shearing.
- Optional channel and section bar shear tooling is available for most models. (See specification chart for details)



*Channel blades. (optional)

Other Included Features

1. Three limit switches enable setting of short notch stroke to improve efficiency. (on IW-50A, IW-60H and S/SD models)
2. Magnetic base LED work light for safer operation. (optional on IW-45M)
3. 1000mm electric backgauge for higher efficiency in repetitious work. The gauge extension is available depending on request.

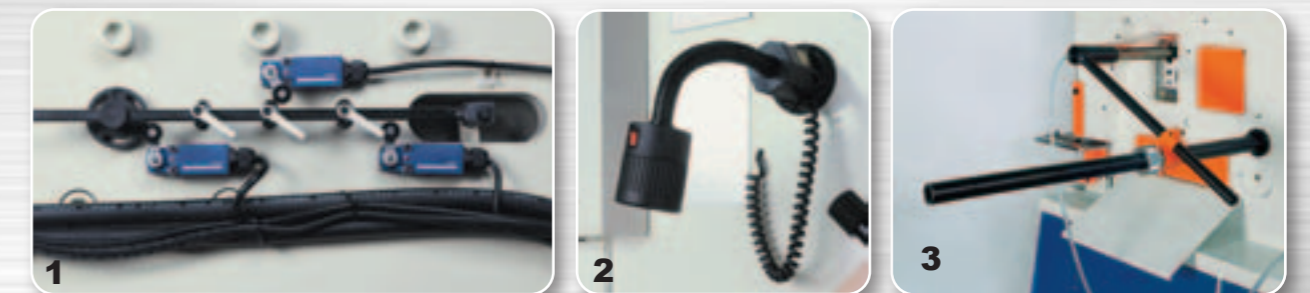

*Optional on IW-45M, IW50A, IW-60H.

K SERIES

K - SERIES IRONWORKERS

The K-series are special designed compact ironworkers with vertical movements at all stations. The entire main slide moves in straight up and down motion to provide the optimum results for punching, shearing, notching, and bending. Hydraulic hold-down and urethane spring stripper are also available for the best performance. The fast cylinder stroke greatly improves the efficiency. This model incorporates versatility, efficiency, accuracy, and ease of use at an excellent price.



Hydraulic hold-down.
(optional on IW-45K / IW-60B)

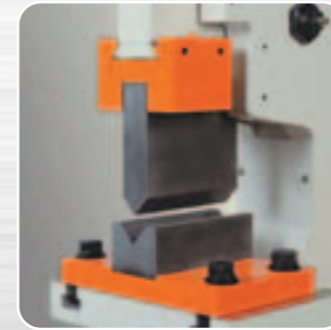

*Single vee press brake.



*Urethane spring stripper.



*Multi vee press brake.

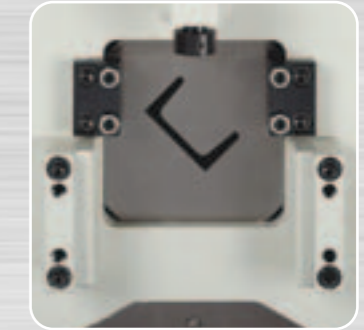

*Channel Shear.



IW-45K



IW-60K



IW-60B



IW-85KD

SINGLE CYLINDER

Single Cylinder Models

IW-45M

The IW-45M has four standard stations, capable of a wide range of applications. The punching station can be converted into a notching station. IW-45M is heavier and stronger than other competitive machines. This durable and economical model is perfect for small shops with a limited budget.

IW-50A

The IW-50A features a vertical moving ram at the punching station which improves the punching result and enables use of optional tooling such as pipe notching and press braking tool. The square/round bar shear is a stand-alone station with the possibility of optional channel shear and section bar shear tooling. This model also features lower angle shearing and bar shearing stations.

IW-60H

The IW-60H features the "Z" shape aperture at the angle shear station, which makes this model capable of doing both the internal and external miter shear on angles. The round/square bar shearing on this model is a stand-alone station that has large shearing capability.



IW-45M



IW-50A



IW-60H

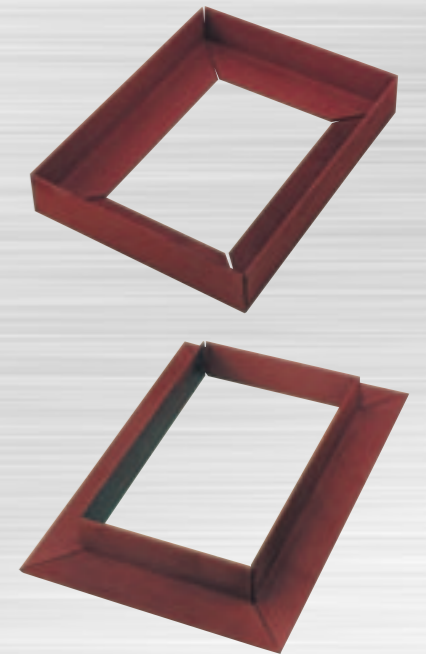

K - SERIES IRONWORKERS

Capacities and Specifications

Unit: mm

MODEL	IW-45K	IW-60K	IW-60B	IW-85KD
PUNCHING				
Punching Force	45 Ton	60 Ton	60 Ton	85 Ton
Punch Capacity (Diameter x Thickness)	ø22 x 15 ø40 x 8	ø22 x 20 ø40 x 11	ø22 x 20 ø40 x 11	ø27 x 22 ø50 x 12
Throat Depth	165	200	200	410
Channel Flange Punch	--	--	--	180
Maximum Stroke Length	30	40	40	100
Cycles / Min. (15mm stroke)	37	34	34	38
Working Height Up to Die	1050	1050	1050	1050
ANGLE SHEARING				
Shearing Force	45 Ton	60 Ton	60 Ton	110 Ton
Shearing Cylinder Stroke Length	--	--	--	50
At 90° Shearing	75 x 75 x 6	100 x 100 x 8	100 x 100 x 8	130 x 130 x 12
Working Height	1000	1070	1070	1040
FLAT SHEARING				
Flat Bar Shear	300 x 10	350 x 15	350 x 15	406 x 17
Blade Length	310	360	360	410
Working Height	800	805	805	726
BAR SHEARING				
Round Bar Shear	ø30	ø40	ø40	ø45
Square Bar Shear	25 x 25	38 x 38	38 x 38	45 x 45
Channel Shear	76*	102*	102*	152*
I Beam Shear	76*	102*	102*	152*
NOTCHING				
Rectangular Notcher (W x D x T)	50.8 x 90 x 7	50.8 x 90 x 8	--	63.5 x 90 x 12
Vee-Notcher (Side x Side x T)	90 x 90 x 8*	90 x 90 x 8*	--	105 x 105 x 12*
Channel Notching	--	--	--	180 ~ 200
Working Height	1050	1050	--	1050
SPECIAL TOOLING				
Large Vee-Notcher (Side x Side x T)	--	--	--	145 x 145 x 10*
Single Vee Press Brake (W x T)	160 x 8*	160 x 8*	160 x 8*	250 x 15*
Multi Vee Press Brake (W x T)	250 x 4*	250 x 6*	300 x 6	500 x 5*
Angle Bending	65 x 8*	65 x 8*	65 x 8*	102 x 8*
Pipe Notching	ø60*	ø60*	ø60*	ø100*
OTHER				
Electric Power (HP)	5 HP	7.5 HP	7.5 HP	10 HP
Net Weight (Apr.)	840 kg	1180 kg	1285 kg	2750 kg
Gross Weight (Apr.)	940 kg	1320 kg	1435 kg	2900 kg
Machine Dimension (Apr.)	1050 x 760 x 1490	1180 x 760 x 1630	1380 x 760 x 1630	1795 x 1020 x 1865
Packing Dimension (Apr.)	1320 x 920 x 1770	1450 x 920 x 1910	1700 x 890 x 1940	2150 x 1180 x 2170

* : Optional Tooling

Note: Based on low carbon / mild steel material strength of 45kg / mm² tensile.
Design and specifications subject to change without notice.

SINGLE CYLINDER IRONWORKERS

Capacities and Specifications

Unit: mm

MODEL	IW-45M	IW-50A	IW-60H
PUNCHING			
Punching Force	45 Ton	50 Ton	60 Ton
Punch Capacity (Diameter x Thickness)	ø22 x 15 ø40 x 8	ø20 x 18 ø40 x 9	ø28 x 15 ø40 x 11
Throat Depth	175	180	220
Maximum Stroke Length	35	42	55
Cycles / Min. (15mm stroke)	31	24	29
Working Height Up to Die	970	840	1000
ANGLE SHEARING			
At 90° Shearing	80 x 80 x 8	100 x 100 x 10	100 x 100 x 13
At 45° Miter Shearing	50 x 50 x 6	65 x 65 x 8	80 x 80 x 8
Working Height	1120	850	1236
FLAT SHEARING			
Flat Bar Shear (Width x Thickness)	350 x 8 180 x 12	300 x 12 200 x 18	350 x 15 210 x 20
Blade Length	360	310	360
Angle Flange Trim	75	100	100
Working Height	970	1150	1006
BAR SHEARING			
Round Bar Shear	ø25	ø32	ø40
Square Bar Shear	25 x 25	30 x 30	38 x 38
Channel Shear	--	76*	102*
I Beam Shear	--	76*	102*
Working Height	1190	880	1260
NOTCHING			
Rectangular Notcher (W x D x T)	50.8 x 90 x 7**	50.8 x 90 x 7	50.8 x 90 x 8
Vee-Notcher (Side x Side x T)	90 x 90 x 8**	90 x 90 x 8*	90 x 90 x 10*
Working Height	--	1150	1006
SPECIAL TOOLING			
Single Vee Press Brake (W x T)	160 x 6*	160 x 10*	160 x 8*
Multi Vee Press Brake (W x T)	--	250 x 6*	--
Angle Bending	65 x 8*	65 x 8*	65 x 10*
Pipe Notching	--	ø60*	--
OTHER			
Electric Power (HP)	5HP	5HP	7.5HP
Net Weight (Apr.)	830 kg	1130 kg	1500 kg
Gross Weight (Apr.)	930 kg	1250 kg	1650 kg
Machine Dimension (Apr.)(LxWxH)	1260 x 700 x 1350	1310 x 770 x 1450	1460 x 770 x 1560
Packing Dimension (Apr.)(LxWxH)	1530 x 860 x 1630	1580 x 930 x 1730	1730 x 930 x 1840

* : Optional Tooling

** : On IW-45M the notcher is optional tooling to be installed at the punching station.

Note: Based on low carbon / mild steel material strength of 45kg / mm² tensile.
Design and specifications subject to change without notice.

A 1-hole die holder and a 2-piece gauging table are provided as standard equipment on all single cylinder models.

S/SD SERIES

Double Cylinder Models

The double cylinder "S/SD" series are in the Sunrise tradition of well engineered ironworkers built for high power, quality, and reliability. These ironworkers have two control foot pedals, and separate operations can be safely performed simultaneously. The low pressure setting for tool change provides maximum operation safety. The long punching cylinder stroke and deep throat enable mounting a wide range of special equipment. The large punching base with the "T-slot" mounting provides a solid base for securing the punching tooling, as well as a wide range of optional and custom designed tooling.



IW-100S

Capacities and Specifications

Unit: mm

MODEL	IW-60S IW-60SD	IW-80S IW-80SD	IW-100S IW-100SD	IW-125S IW-125SD	IW-165SD
PUNCHING					
Punching Force	60 Ton	80 Ton	100 Ton	125 Ton	165 Ton
Punch Capacity (Diameter x Thickness)	ø22 x 20 ø50 x 9	ø26 x 22 ø50 x 12	ø28 x 26 ø50 x 15	ø33 x 27 ø50 x 18	ø37 x 32 ø50 x 24
Throat Depth	S: SD: 310 510	310 510	310 510	310 510	-- 510
Channel Flange Punch (Height)	180	180	180	180	180
Maximum Stroke Length	100	100	100	100	100
Cycles / Min. (20mm stroke)	30	29	28	28	29
Working Height Up to Die	1010	1050	1044	1069	1050
ANGLE SHEARING					
At 90° Shearing	130 x 130 x 13	152 x 152 x 13	152 x 152 x 15	152 x 152 x 18	205 x 205 x 20
At 45° Miter Shearing	65 x 65 x 8	80 x 80 x 10	80 x 80 x 10	80 x 80 x 10	80 x 80 x 10
Working Height	1115	1165	1216	1185	1185
FLAT SHEARING					
Flat Bar Shear (Width x Thickness)	350 x 15 240 x 20	460 x 15 300 x 20	610 x 16 400 x 20	610 x 18 400 x 25	760 x 20 400 x 30
Blade Length	360	465	620	620	770
Angle Flange Trim	100	100	100	100	120
Working Height	910	926	954	920	920
BAR SHEARING					
Round Bar Shear	ø40	ø45	ø45	ø50	ø60
Square Bar Shear	38 x 38	45 x 45	45 x 45	50 x 50	60 x 60
Channel Shear	130*	152*	152*	180*	203*
I Beam Shear	130*	152*	152*	180*	203*
Working Height	1220	1270	1332	1310	1370
NOTCHING					
Rectangular Notcher (W x D x T)	50.8 x 90 x 9	50.8 x 90 x 12	63.5 x 90 x 12	63.5 x 90 x 13	63.5 x 90 x 16
Vee-Notcher (Side x Side x T)	90 x 90 x 10*	90 x 90 x 12*	105 x 105 x 12*	105 x 105 x 13*	105 x 105 x 16*
Working Height	910	926	954	920	920
SPECIAL TOOLING					
Large Vee-Notcher (Side x Side x T)	145 x 145 x 8*	145 x 145 x 10*	145 x 145 x 12*	145 x 145 x 13*	145 x 145 x 13*
Single Vee Press Brake (W x T)	250 x 15*	250 x 15*	250 x 20*	250 x 20*	250 x 20*
Multi Vee Press Brake (W x T)	500 x 5*	500 x 5*	700 x 5*	700 x 5*	700 x 5*
Angle Bending	102 x 6*	102 x 8*	102 x 13*	102 x 13*	102 x 13*
Pipe Notching	ø100*	ø100*	ø100*	ø100*	ø100*
OTHER					
Electric Power (HP)	7.5 HP	10 HP	10 HP	15 HP	20HP
Net Weight (Apr.)	S: SD: 1800 kg 2200 kg	2180 kg 2650 kg	2950 kg 3450 kg	3340 kg 3950 kg	-- 4950 kg
Gross Weight (Apr.)	S: SD: 1950 kg 2380 kg	2360 kg 2880 kg	3180 kg 3700 kg	3590 kg 4220 kg	-- 5250 kg
Machine Dimension (Apr.) (LxWxH)	S: SD: 1700 x 800 x 1710 2070 x 800 x 1710	1830x820x1760 2210x820x1760	2100x860x1810 2460x860x1810	2170x1030x1850 2490x1030x1850	-- 2710x1070x2010
Packing Dimension (Apr.) (LxWxH)	S: SD: 1970 x 960 x 1990 2340 x 960 x 1990	2100x980x2040 2480x980x2040	2370x1020x2090 2730x1020x2090	2440x1190x2130 2760x1190x2130	-- 2980x1230x2290

* : Optional Tooling

Note: Based on low carbon / mild steel material strength of 45kg / mm² tensile.

Design and specifications subject to change without notice.

A 2-hole overhang die holder and a 2-piece gauging table are provided as standard equipment on all dual cylinder ironworkers.

PM SERIES

Hydraulic Punching Machine

- The patented dual-piston hydraulic cylinder enables the machine to retract faster, and also makes our cylinder slimmer, which brings a better appearance to the machine.
- Punching machines ranging from 35 to 200 tons of punching capacities, combined with different throat depths to choose from, provides a complete range of models to meet our customer's wide range of requirements.
- All optional tooling used on the punching station of S/SD ironworkers can also be used on the PM models, turning the punching machine into a universal machine.



PM-55LT



*Bar shearing.



*Channel shearing.



*Angle shearing.



*Flat bar shearing.



*Rectangular notcher.

Capacities and Specifications

Unit: mm

MODEL	PM-35T PM-35LT PM-35XT	PM-55T PM-55LT PM-55XT	PM-80T PM-80LT PM-80XT	PM-120LT PM-120XT	PM-160LT PM-160XT	PM-200LT PM-200XT
PUNCHING						
Punching Force	35 Ton	55 Ton	80 Ton	120 Ton	160 Ton	200 Ton
Punch Capacity (Diameter x Thickness)	ø18 x 14 ø50 x 5	ø22 x 18 ø50 x 8	ø25 x 23 ø50 x 12	ø32 x 27 ø50 x 17	ø36 x 32 ø50 x 23	ø41 x 35 ø50 x 29
Channel Flange Punch (Height)	180	180	180	180	180	180
Throat Depth	T: 310 LT: 510 XT: 760	T: 310 LT: 510 XT: 760	T: 310 LT: 510 XT: 760	-- 510 760	-- 510 760	-- 510 760
Maximum Stroke Length	100	100	100	100	100	100
Cycles/Min. (20mm stroke)	41	28	28	26	27	28
Table Size (W x D)	T: 700 x 500 LT: 700 x 700 XT: 700 x 950	T: 700 x 500 LT: 700 x 700 XT: 700 x 950	T: 700 x 500 LT: 700 x 700 XT: 700 x 950	-- 700 x 700 700 x 950	-- 700 x 700 700 x 950	-- 700 x 700 700 x 950
Working Height Up to Die	1050	1050	1050	1050	1050	1050
OPTIONAL TOOLING						
Largest Hole*	ø160 x 2	ø160 x 3	ø160 x 4	ø200 x 6	ø200 x 8	ø200 x 10
Single Vee Press Brake (W x T)*	250 x 12	250 x 15	250 x 15	250 x 20	250 x 20	250 x 20
Multi Vee Press Brake (W x T)*	500 x 3	500 x 5	500 x 5	700 x 5	700 x 5	700 x 5
Angle Bending*	102 x 6	102 x 9	102 x 13	102 x 13	102 x 13	102 x 13
Rectangular Notcher (WxDxT)*	63.5 x 90 x 6	63.5 x 90 x 8	63.5 x 90 x 10	63.5 x 90 x 13	63.5 x 90 x 13	63.5 x 90 x 13
Vee Notcher (Side x Side x T)*	145 x 145 x 5	145 x 145 x 6	145 x 145 x 10	145 x 145 x 12	145 x 145 x 13	145 x 145 x 13
Pipe Notcher (Max diameter)*	ø100	ø100	ø100	ø100	ø100	ø100
Flat Bar Shearing*	175 x 5	175 x 7	175 x 10	175 x 14	175 x 16	175 x 16
Angle Shearing*	75 x 75 x 6	100 x 100 x 7	100 x 100 x 10	100 x 100 x 13	100 x 100 x 13	100 x 100 x 13
Round Bar Shearing*	ø32	ø32	ø32	ø32	ø32	ø32
Square Bar Shearing*	28 x 28	32 x 32	32 x 32	32 x 32	32 x 32	32 x 32
Channel Shearing*	102 x 51	102 x 51	102 x 51	102 x 51	102 x 51	102 x 51
OTHER						
Electric Power	5 HP	5 HP	7.5 HP	10 HP	15 HP	20 HP
Net Weight (Apr.)	T: 1200 kg LT: 1500 kg XT: 1840 kg	T: 1450 kg LT: 1850 kg XT: 2200 kg	T: 1780 kg LT: 2100 kg XT: 2845 kg	-- 2840 kg 3600 kg	-- 3550 kg 4600 kg	-- 4440 kg 5600 kg
Gross Weight (Apr.)	T: 1300 kg LT: 1640 kg XT: 2000 kg	T: 1620 kg LT: 2050 kg XT: 2420 kg	T: 1960 kg LT: 2300 kg XT: 3060 kg	-- 3080 kg 3860 kg	-- 3860 kg 5000 kg	-- 4800 kg 5960 kg
Machine Dimension (Apr.) (L x W x H)	T: 1090x820x1770 LT: 1420x820x1795 XT: 1820x820x1815	T: 1160x820x1960 LT: 1520x820x1960 XT: 1920x820x1960	T: 1280x865x1980 LT: 1620x865x1980 XT: 2045x865x1980	-- 1720x970x2035 2170x970x2035	-- 1870x1040x2070 2370x1040x2135	-- 1975x1265x2095 2475x1265x2175
Packing Dimension (Apr.) (L x W x H)	T: 1410x970x2010 LT: 1740x970x2035 XT: 2140x970x2055	T: 1480x970x2200 LT: 1840x970x2200 XT: 2240x970x2200	T: 1600x1015x2220 LT: 1940x1015x2220 XT: 2365x1015x2220	-- 2040x1120x2275 2490x1120x2275	-- 2190x1190x2310 2690x1190x2375	-- 2295x1415x2335 2795x1415x2415

* : Optional Tooling

Note: Based on low carbon / mild steel material strength of 45kg / mm² tensile.

Design and specifications subject to change without notice.

A 2-hole overhang die holder and a 2-piece gauging table are provided as standard equipment on all punching machines.

Semi-Automatic

The semi-automatic CNC positioning tables from SUNRISE are plate, angle and channel positioning systems with simple user-friendly interfaces. The CNC positioning table is available as a factory-installed option on any Dual-Cylinder Ironworker or Punching Machine with a 510mm or larger throat depth. The operation is CNC controlled using a pendant mounted controller featuring easy programming and a virtually indestructible design. The operator simply positions the plate against the CNC-controlled X and Y stops and initiates the punch sequence. Ideal for base plates, connection plates, angles, channels and more.

Optional Multi-tool system:

- Standard punches and dies used on multi-tool system
- Each punch is individually controlled by pneumatic cylinders
- Tooling is color coded in preview screen

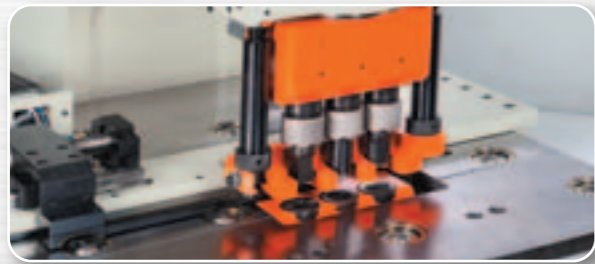

Main Features:

- Preview function before executing program
- Four pre-programmed patterns: Line, Array, Arc, and Custom
- Spotting function using low pressure mode
- Maximum table travel speed: 10m/min
- Table accuracy without load $\pm 0.05\text{mm}$



Omron 10" touch screen controller



*Optional oversize punch



*Optional angle leg up stripper



IWNC-165SD
1000x400mm Semi-Automatic Table



IWNC-125SD
3000x400mm Semi-Automatic Table

- *Maximum table travel speed without load: 10m/min
- *Machined steel frame design
- *Mitsubishi servo motors
- *Name brand linear actuator with 3000mm travel for maximum performance
- *Ball transfers on table for smooth material handling



Fully-Automatic

Fully-automatic CNC systems from SUNRISE deliver highly efficient and accurate positioning that will improve your productivity. The controller is easy to learn and operate, so you can begin operations almost immediately. Hydraulic clamps come with a pressure sensor for a strong grip on the material, and come standard on Sunrise automatic CNC tables. Moreover, the included hydraulic stripper comes with exchangeable plates to suit a variety of punching operations. Ball transfer units on the support table provide smooth material movement, and the cover is complete with an interlock switch for ensured operator safety.

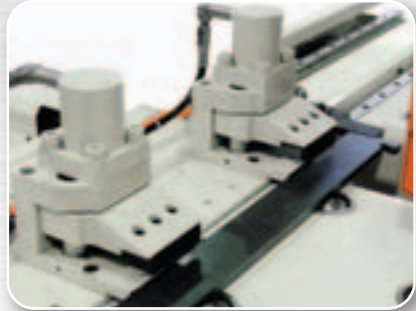

Operate in semi-automatic mode with use of gauging piece allows punching holes near the edge of the material.

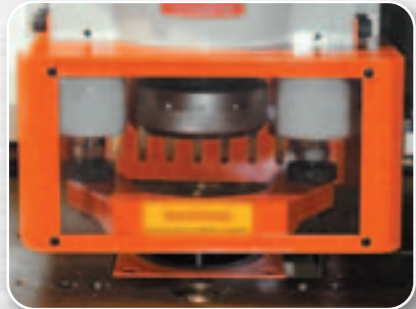

Hydraulic stripper to reduce material deformation is standard equipment.

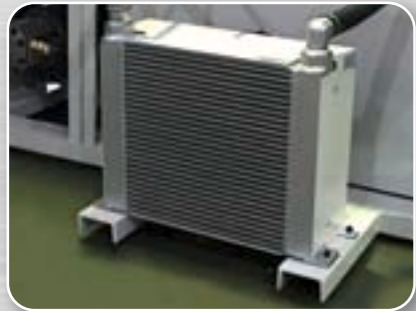

Oil cooling system

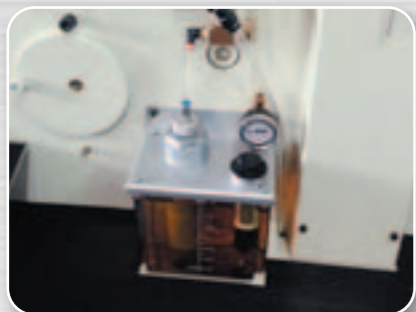

*Auto lubrication system with adjustable frequency and oil amount for longer tool life.



PM-80LT-CNC
1000x500mm Fully-Automatic Table

Controller Features

- Omron HMI and PLC for high reliability.
- Very user friendly interface for easy operation.
- Preview work piece before executing.
- Pre-programmed common patterns to get you started immediately.
- CF card slot for data backup.



PC Based Controller Upgrade *Selective models only and no retrofit.



- *15" touch screen
- *Windows 7 Embedded
- *USB and Ethernet ports for flexible connectivity
- *Direct ACAD.dxf file import
- *Real time graphic preview and scaling
- *Tool base for tooling management
- *Punching sequence editing



*Nexcom industrial grade fanless PC
*i7 CPU/2G DDR3/128G SSD HDD

CNC Positioning System



The new line of Sunrise CNC positioning and feeding system uses a heavily proportioned machined structural steel tube that provides unmatched rigidity and quality, yet offers simple set-up, adjustment and maintenance.

The ANC combines a punching machine with a single-axis in-feed system for punching flat bar, angle and channel webs.

The APS automatic punch and shear combines a punching machine with a shearing machine and a CNC in-feed system for punching and shearing flat bars in one fully automatic operation.

The in-feed system is standard at 6000mm X-travel with option to extend longer. The touch screen controller is podium mounted for easy placement according to job needs and features pre-set patterns making programming a simple task.

APS-30080M

- Max. material: 300x18x6000mm
- Feeding speed: 12m/min
- Accuracy: ± 0.5 mm per meter
- Clamps for both X and Y directions
- Anti-twist shearing support
- Fully covered with interlock for safety
- 30-40-30 Multi-tool system for max. $\varnothing 40$ mm holes.



The user friendly 7" color touch-screen controller with pre-set patterns makes programming a simple task.



PM-80T-ANC

- *X-Axis travel length: 6m
- *Angle size range: 2"~8" (require special punching accessories)
- *X-Axis positioning speed: 12m/min
- *X-Axis accuracy: ± 0.5 mm per meter
(material condition may effect actual punched holes)
- *Punches per minute: up to 28 (at 20mm stroke)





**SUNRISE
Fluid Power Inc.**

No. 7, Road 12, Industrial Zone,
Taichung City 407, Taiwan
TEL: 886-4-2359-1190
FAX: 886-4-2359-3409
www.sunriseiw.com.tw
sales@sunriseiw.com.tw

AGENT :

